

**LA1260**

FM/AM Tuner System for Radio-Cassette Recorders, Music Centers

Functions

FM : IF amplifier, quadrature detector, AF preamplifier,
tuning indicator drive output.

AM : RF amplifier, MIX, OSC (with ALC), IF amplifier,
Detector, AGC, tuning indicator drive.

Features

- Minimum number of external parts required (No AM detection coil required).
- High S/N : FM 81dB
AM 53dB
- Low-level AM oscillator with ALC : Pin 16 OSC output
MW 130mV
SW 70 mV to 90 mV
(7MHz) (24MHz)
- Less AM whistle interference : Whistle 1% at input 100dB/m.
- On-chip LED tuning indicator driver.
- On-chip FM/AM selector.
- Independent FM/AM output pins : Possible to set FM/AM frequency characteristic independently.

Package Dimensions

unit : mm

3006B-DIP16

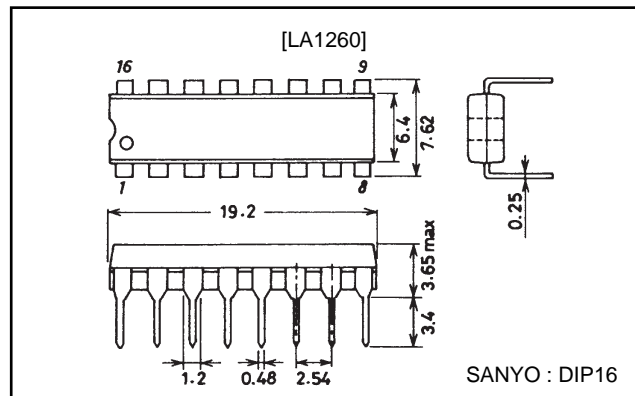

Specifications

Maximum Ratings at $T_a=25^\circ\text{C}$, See specified Test Circuit.

Parameter	Symbol	Conditions	Ratings	Unit
Maximum supply voltage	$V_{CC \text{ max}}$	Pins 6, 12	9	V
Maximum current drain	$I_{CC \text{ max}}$	Pins 6+7+12	50	mA
Flow-in current	I_7	Pin 7	20	mA
Flow-out current	I_{15}	Pin 15	0.1	mA
Allowable power dissipation	$P_d \text{ max}$	$T_a \leq 70^\circ\text{C}$	450	mW
Operating temperature	T_{op}		-20 to +70	$^\circ\text{C}$
Storage temperature	T_{stg}		-40 to +125	$^\circ\text{C}$

Operating Conditions

 at $T_a=25^\circ\text{C}$

Parameter	Symbol	Conditions	Ratings	Unit
Recommended operating voltage	V_{CC}		4.5	V
Operating voltage range	$V_{CC \text{ op}}$		3.0 to 8.0	V

LA1260

Operating Characteristics at $T_a=25^\circ\text{C}$, $V_{CC}=4.5\text{V}$, See specified Test Circuit

Parameter	Symbol	Conditions	Ratings			Unit
			min	typ	max	
[AM Characteristics : $f=1\text{MHz}$]						
Quiescent current	$I_{CCO\text{AM}}$	$V_{IN}=\text{No input}$		7.5	10.5	mA
Detection output	V_{O1}	$V_{IN}=23\text{dB}\mu$, 400Hz-30% mod.	-33	-28	-23	dBm
			17.3	31	55	mV
S/N ratio	S/N1	$V_{IN}=23\text{dB}\mu$, 400Hz-30% mod.	18.0	21.5		dB
Detection output	V_{O2}	$V_{IN}=60\text{dB}\mu$, 400Hz-30% mod.	-19.0	-16.0	-13.0	dBm
			87	122	174	mV
S/N ratio	S/N2	$V_{IN}=60\text{dB}\mu$, 400Hz-30% mod.	48	53		dB
Total harmonic distortion	THD1	$V_{IN}=60\text{dB}\mu$, 400Hz-30% mod.		0.45	1.3	%
	THD2	$V_{IN}=100\text{dB}\mu$, 400Hz-30% mod.		1.5	3.0	%
LED lighting voltage	V_{LEDAM}	$I_C=1\text{mA}$	22	30	38	dBm
Oscillation output (24MHz)	V_{OSC24M}		60	86	120	mV
[FM Characteristics : $f=10.7\text{MHz}$]						
Quiescent current	$I_{CCO\text{FM}}$	$V_{IN}=\text{No input}$		8.5	12.0	mA
-3dB sensitivity	$V_{IN\text{lim}}$	-3dB down, 400Hz-100% mod.		35	42	dB μ
Demodulation output	V_{O3}	$V_{IN}=80\text{dB}\mu$, 400Hz-100% mod.	-12.5	-9.5	-6.5	dBm
			183	260	367	mV
S/N ratio	S/N3	$V_{IN}=80\text{dB}\mu$, 400Hz-100% mod.	77	81		dB
	S/N4	$V_{IN}=80\text{dB}\mu$, 400Hz-30% mod.		71		dB
Total harmonic distortion	THD3	$V_{IN}=80\text{dB}\mu$, 400Hz-100% mod.		0.55	1.2	%
	THD4	$V_{IN}=80\text{dB}\mu$, 400Hz-30% mod.		0.05		%
LED lighting voltage	V_{LEDFM}	$I_L=1\text{mA}$		39	49	dB μ
AM rejection ratio	AMR	$V_{IN}=80\text{dB}\mu$, 400Hz-100% FM mod. 1kHz-30% AM mod.		60		dB

Equivalent Circuit Block Diagram

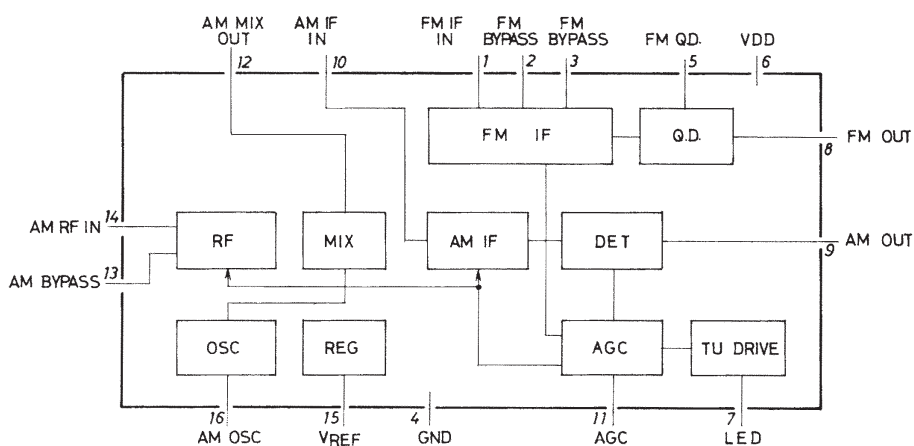

Test Circuit

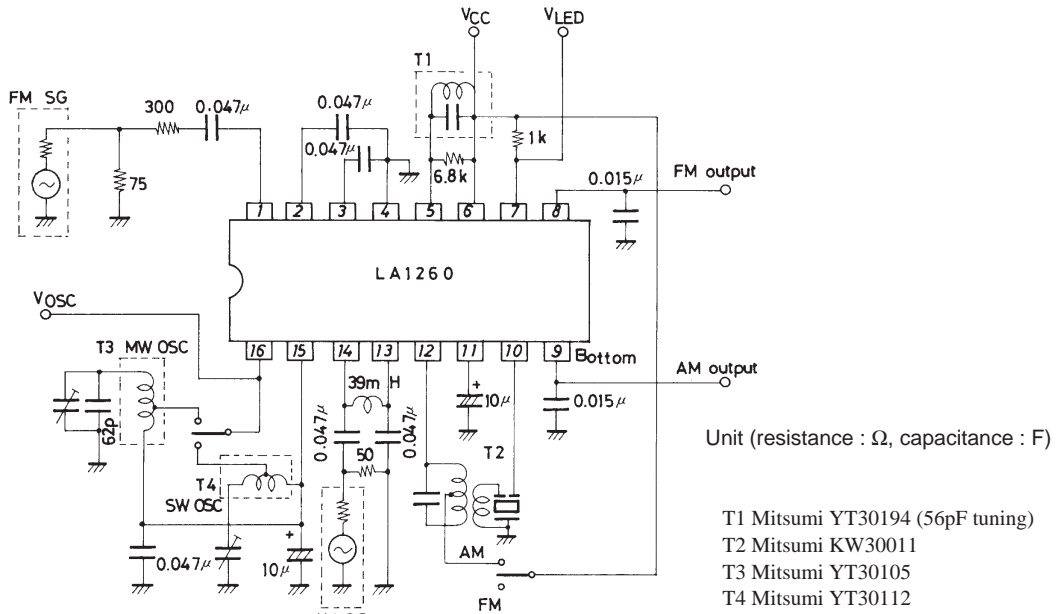

Proper Cares in Using the IC

External parts placement and pattern

- The AM local oscillation parts, AM local oscillation coil, and antenna circuit parts such as bar antenna must be separated from each other as far as possible to prevent Qs from worsening.
- Pin 16 (AM oscillation injection pin) and pin 14 (RF input pin) must be separated from each other on the pattern as shown in Figure. A below. Care should be taken not to make unwanted coupling by parallel wiring as shown in Figure B to prevent Qs from worsening.

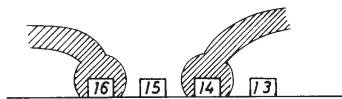

Figure A Good example

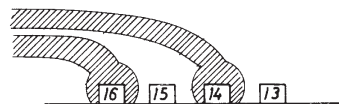

Figure B Bad example

FM quadrature detection coil

- The values recommended for the detection coil are shown below. (See Figure 1.)

Tuning capacitance : 56pF

Damping resistance : 6.8kΩ

- Values other than recommended provide the LED drive characteristic as shown below.

	Value increased	Value decreased
Tuning capacitance	<ul style="list-style-type: none"> • Lighting is delayed. • No lighting may occur at low temperature. 	<ul style="list-style-type: none"> • Lighting is advanced. • Mislighing may occur in the absence of signal.
Damping resistance	<ul style="list-style-type: none"> • Lighting is advanced. • Mislighing may occur in the absence of signal. 	<ul style="list-style-type: none"> • Lighting is delayed. • No lighting may occur at low temperature.

If the product of tuning capacitance and damping resistance is equal to that of values recommended above (e. g. tuning capacitance=82pF, damping resistance=4.7kΩ), other characteristics (demodulation output, S/N, THD, etc.) than the LED drive characteristic remain almost unaffected.

- For applications where a double tuning coil is used, refer to "Applications where a double coil is used" on page 13.

LA1260

How to apply FM AFC

The S curve at the FM output pin (pin 8) is as shown in Figure 1. Therefore, the domestic (Japan) band (lower local oscillation) use and foreign band (upper local oscillation) use differ as shown in Figures 2 and 3.

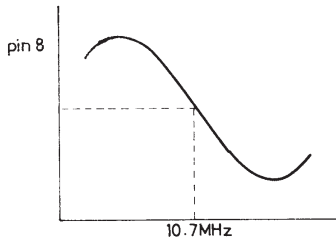

Figure 1

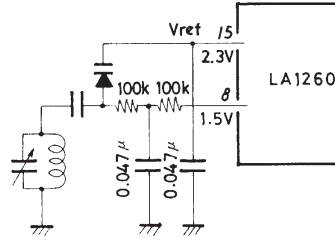

Figure 2 Domestic (lower local oscillation) band

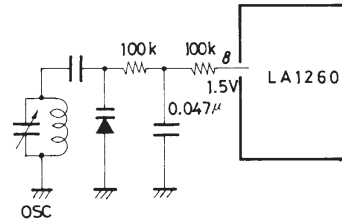
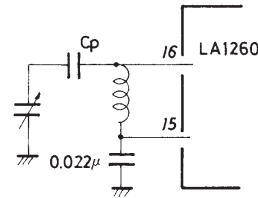
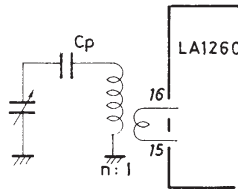
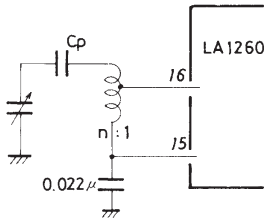

Figure 3 Foreign (upper local oscillation) band

Unit (resistance : Ω , capacitance : F)

AM local oscillation

Since the LA1260 contains an ALC circuit, the oscillation level at pin 16 can be limited to 60 to 150mV in the following applications where a coil is used.



Unit (capacitance : F)

Stable oscillation occurs at a coil impedance of 5k Ω or greater viewed from across pins 16 and 15. Turn ratio n and Q_0 must be determined so that the oscillation level at pin 16 becomes 75mV or greater for MW use and 60mV or greater for SW use.

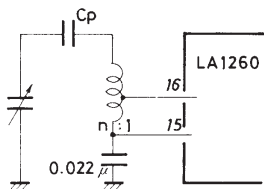

Figure 4

If turn ratio n is increased more than needed, the oscillation level at pin 16 drops, thereby lowering the maximum sensitivity as shown in Figure 5 and 6. Figure 7 shows the relation between turn ratio n and oscillation level at pin 16 in the MW band.

Unit (capacitance : F)

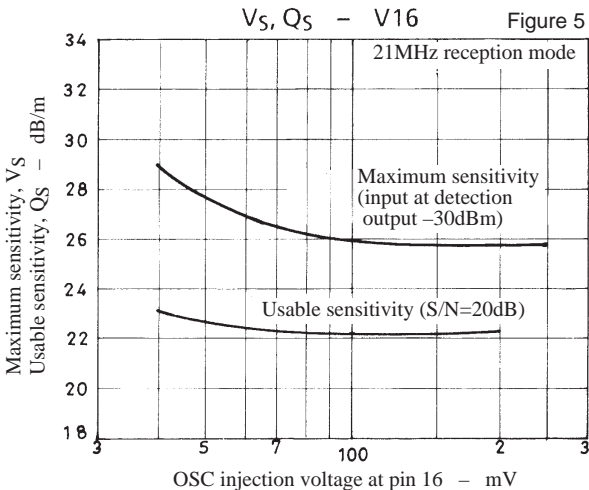

Figure 5

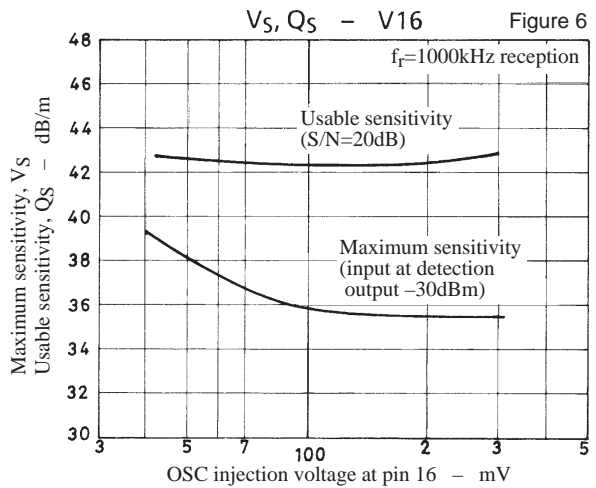
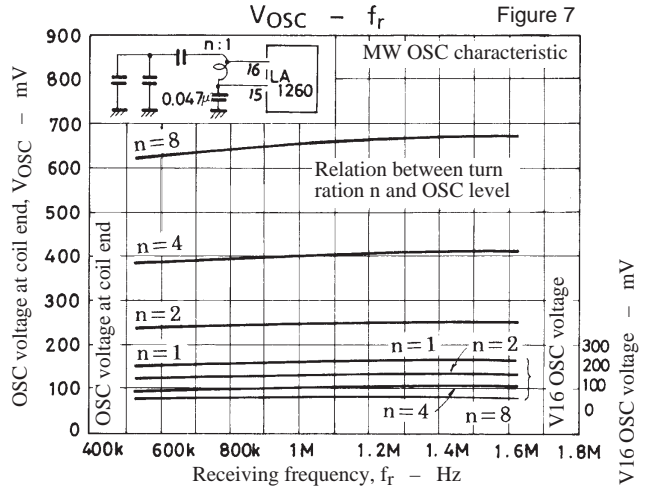
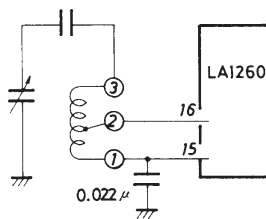

Figure 6



AM oscillation coil



Unit (capacitance : F)

Generally speaking, the following should be noted. Winding with loose coupling between 1 and 2 and between 1 and 3 must be avoided. (Particularly SW1, SW2).

To put in concretely, the pot core type is better than the screw core type which is loose in coupling. This prevents the local oscillation frequency from turning third resonance frequency related to the coupling coefficient.

LED unlighted time and distortion in AM (MW)

By increasing the value of the electrolytic capacitor for AGC at pin 11 (Figure 8), the distortion in the AM mode can be improved, but the LED unlighted time is made longer. $10\mu F$ is recommended for obtaining the optimum LED unlighted time and distortion. The LED unlighted time is 200ms at this value (Approximately 400ms at $22\mu F$).

FM-AM selection and dc level at pin 12

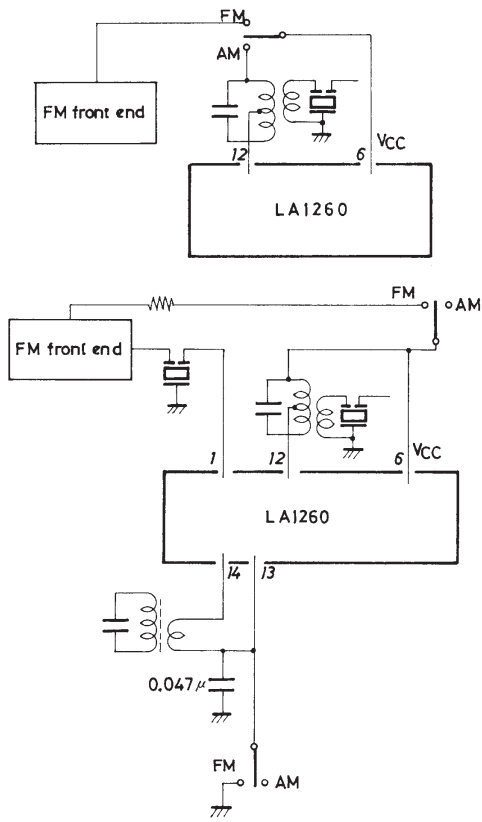

Unit (capacitance : F)

(1) Pin 12-used method=recommended circuit

The FM mode is entered with pin 12 open. When pin 12 and pin 6 are at the same potential in terms of DC, the AM circuit is turned on by the internal switch. It should be noted that the dynamic range is narrowed whether the potential at pin 12 is lower or high than that at pin 6.

(2) Pin 13-used method

The AM mode is entered with pin 13 open. When pin 13 is grounded, the FM circuit is turned on and the AM circuit is turned off by the internal switch. In this case, pin 12 and pin 6 (V_{CC}) are at the same potential.

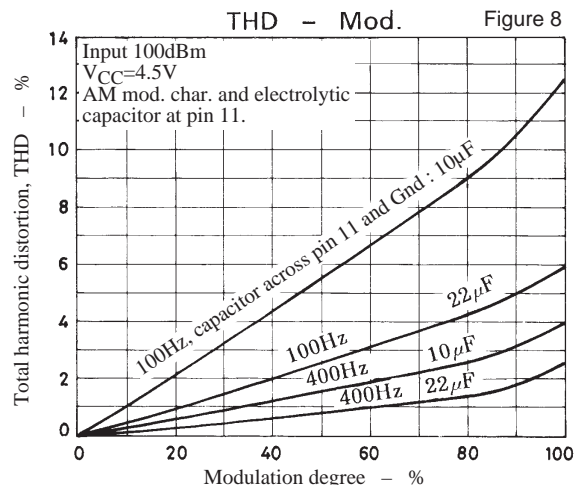

LA1260

FM IF/MW Test Circuit

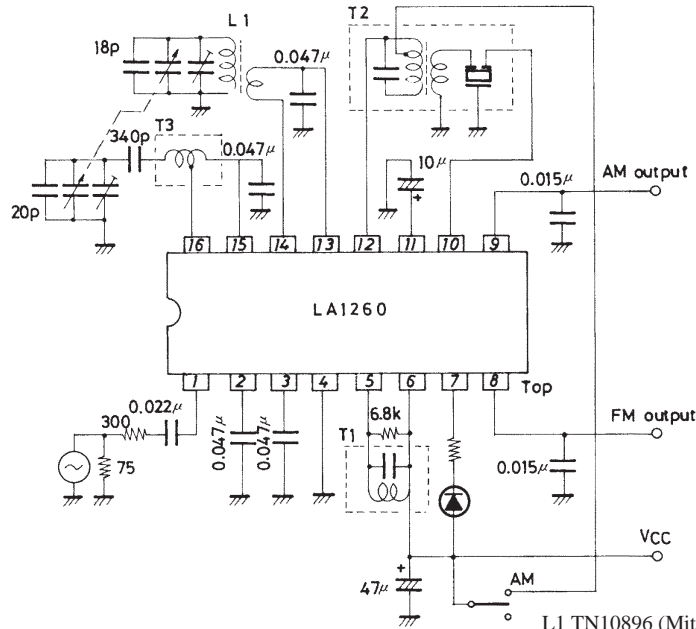

- L1 TN10896 (Mitsumi)
- T1 YT-30194 (Mitsumi), 2153-4095-239 (Sumida)
- T2 KW-30011 (Mitsumi)
- T3 YT-30105 (Mitsumi)

Unit (resistance : Ω, capacitance : F)

[FM Characteristics]

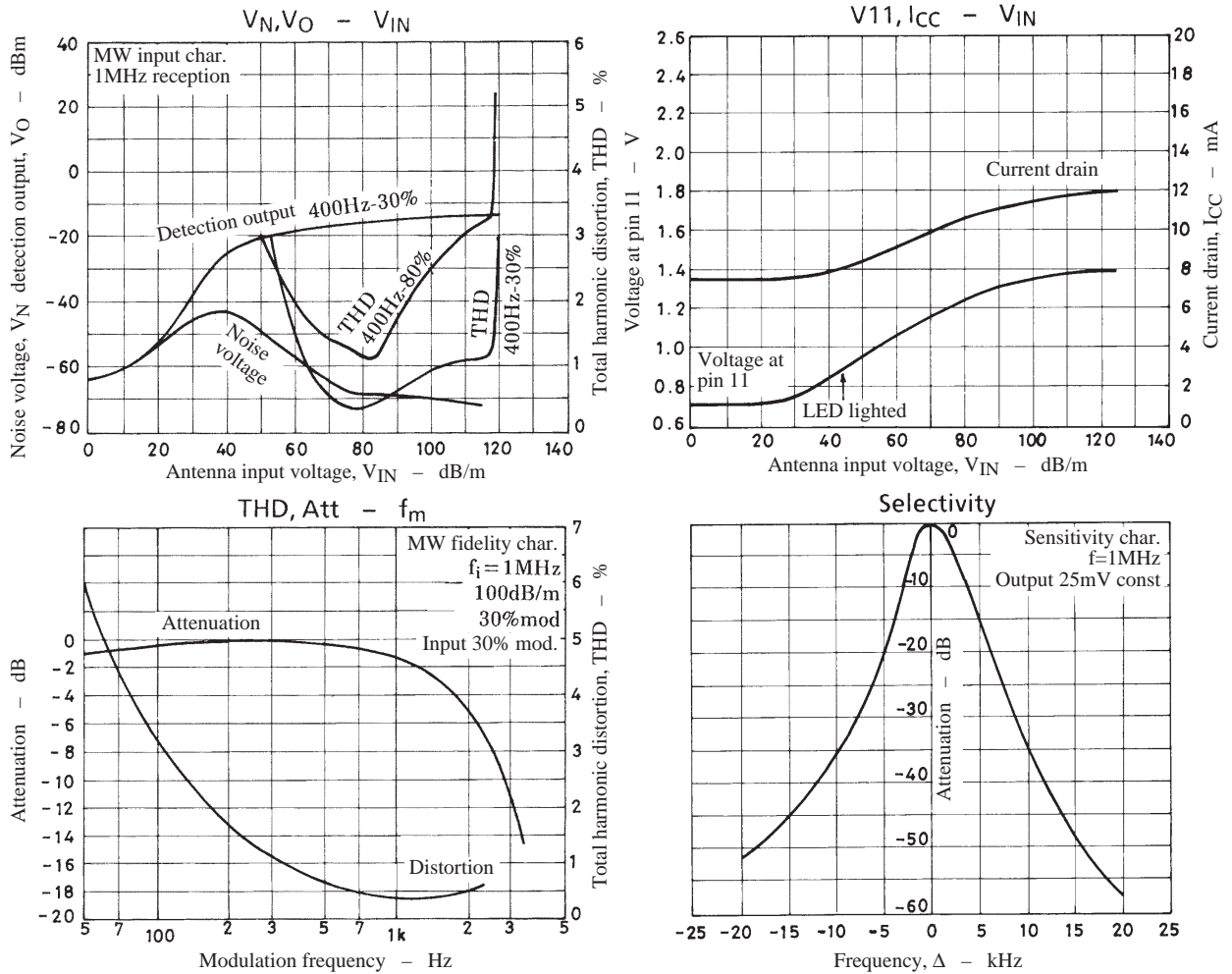

Detuning Characteristic

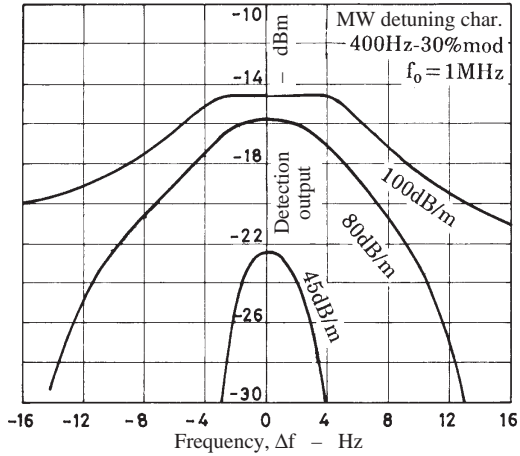

MW Receiving Characteristics

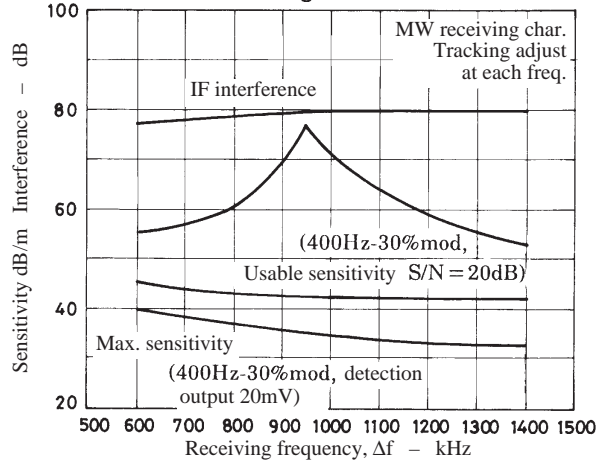

MW Receiving Characteristics

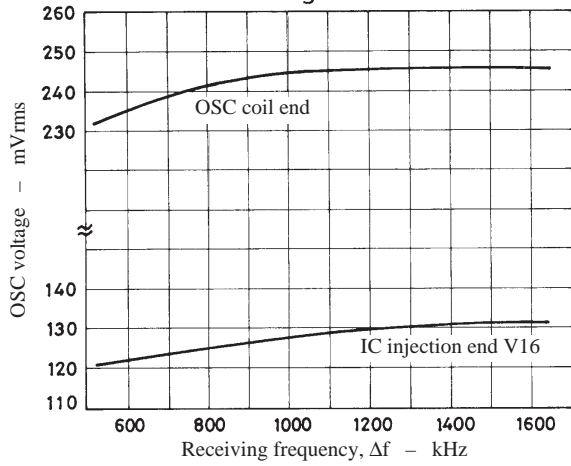

MW Receiving Characteristics

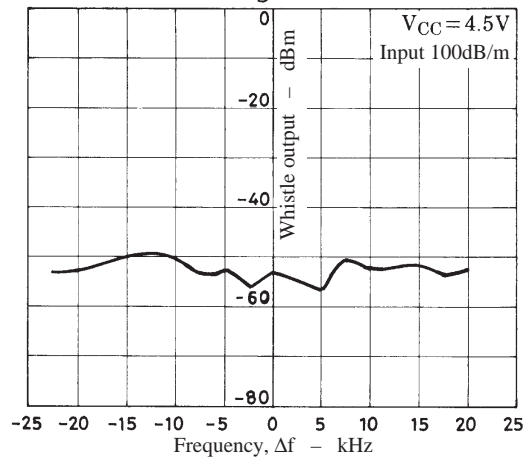

MW Beat Characteristics

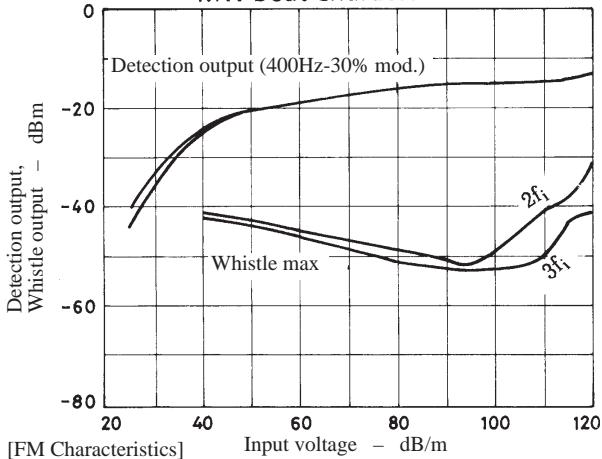

Spurious Response

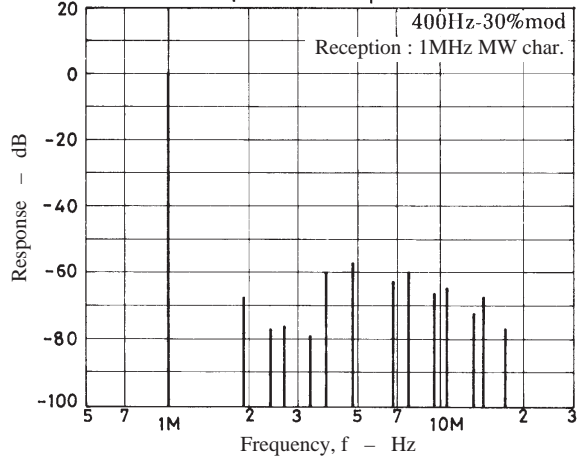

[FM Characteristics]

FM Receiving Characteristics

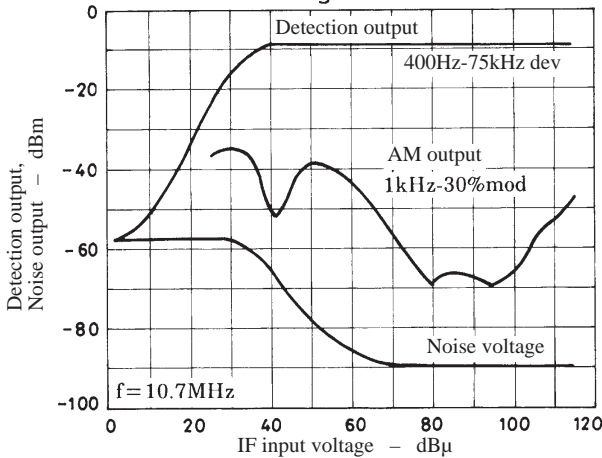

FM Receiving Characteristics

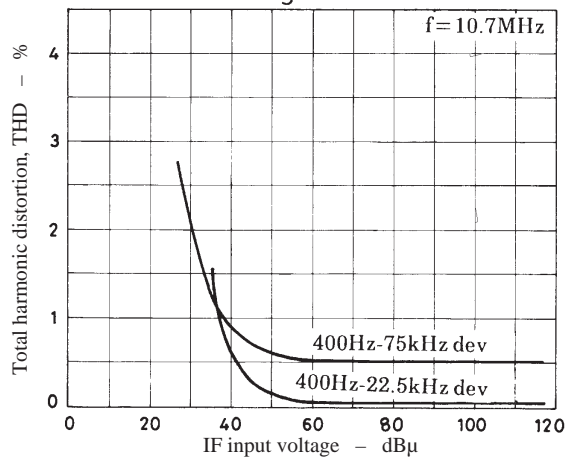

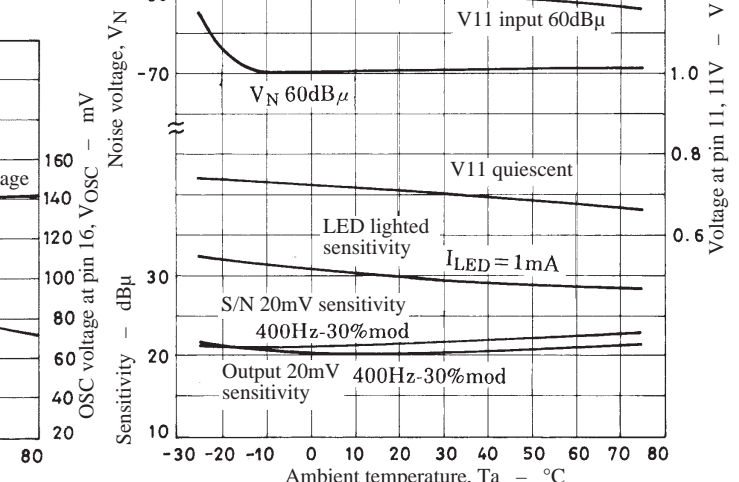
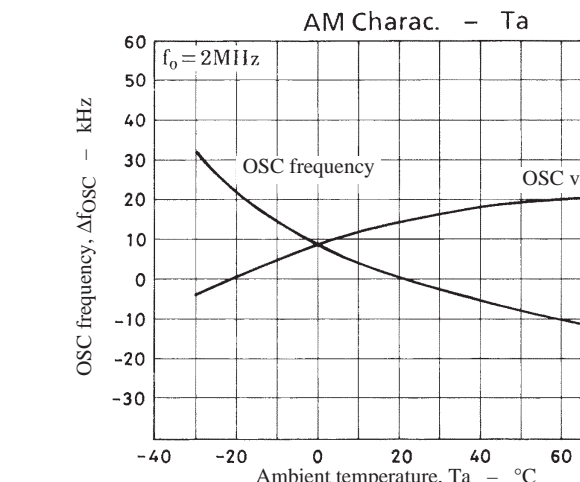
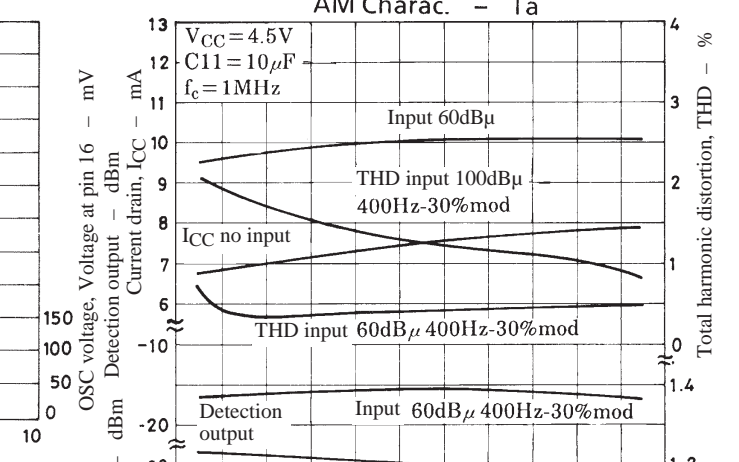
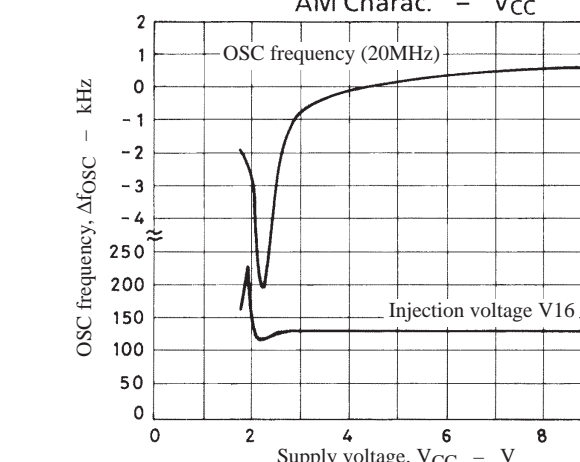
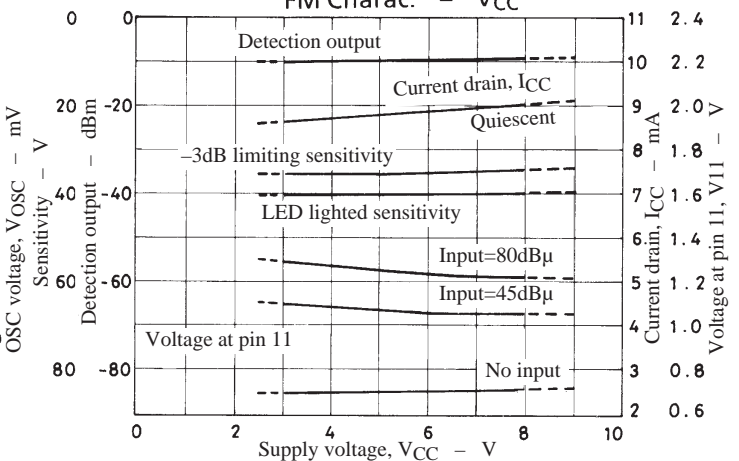
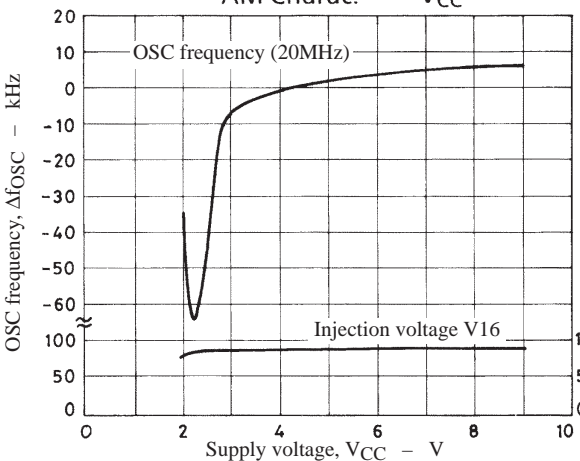
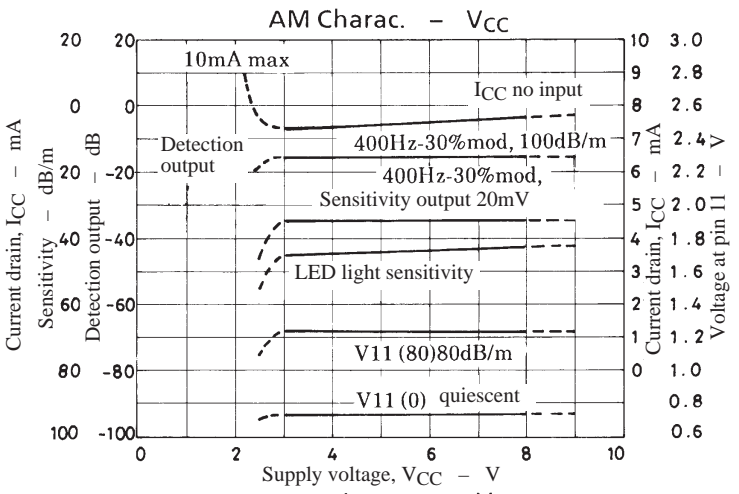
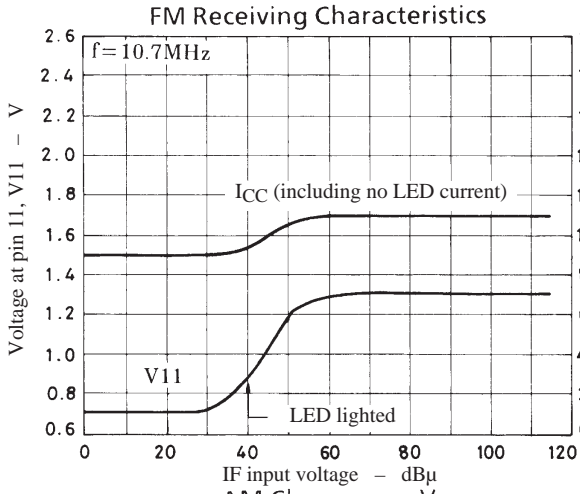

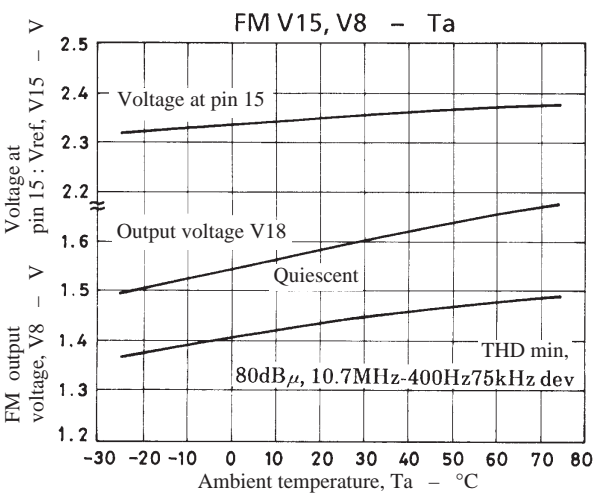
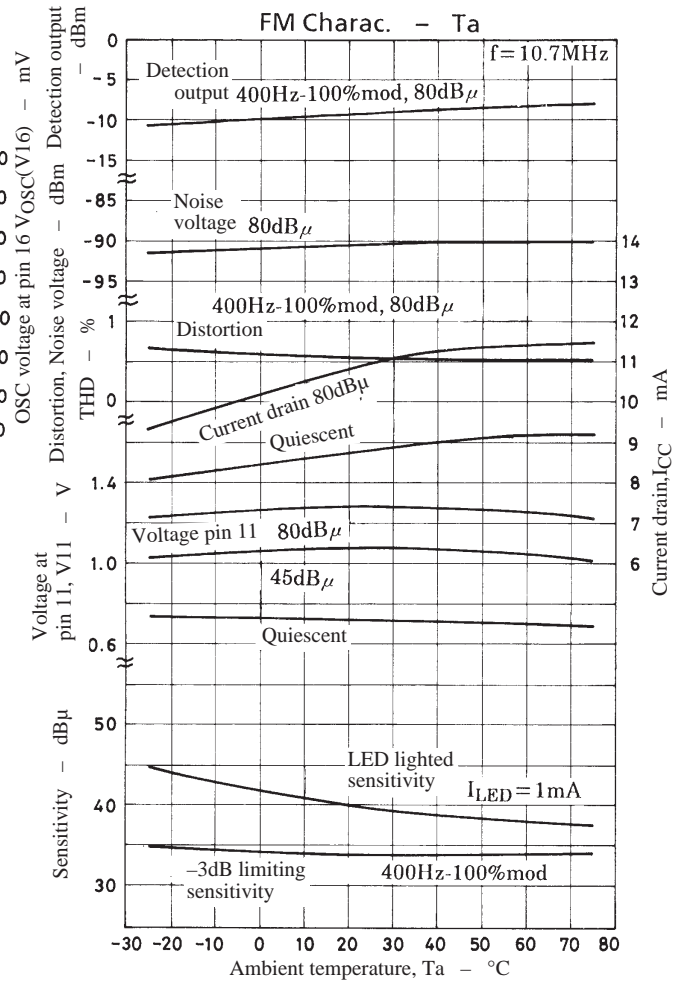
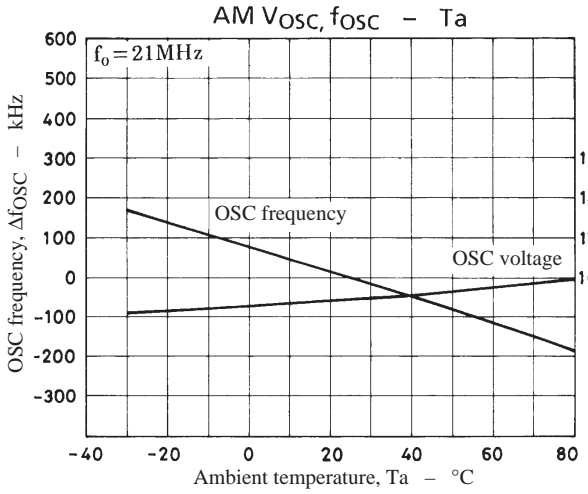

Sample Application Circuit 1 : FM IF/SW2 (7.2 to 24.0MHz)

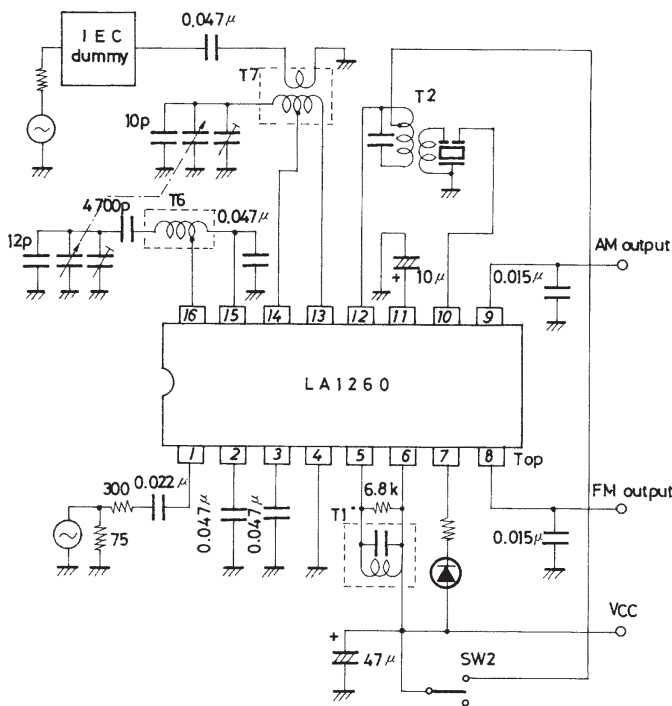

- T1 YT-30194 (Mitsumi), 2153-4095-339 (Sumida)
- T2 KW-30011 (Mitsumi)
- T6 YT-30112 (Mitsumi)
- T7 YT-30117 (Mitsumi), 2158-4140-044 (Sumida)

Unit (resistance : Ω , capacitance : F)

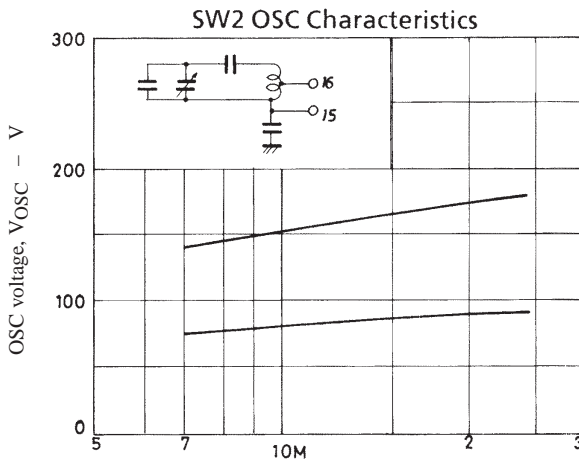
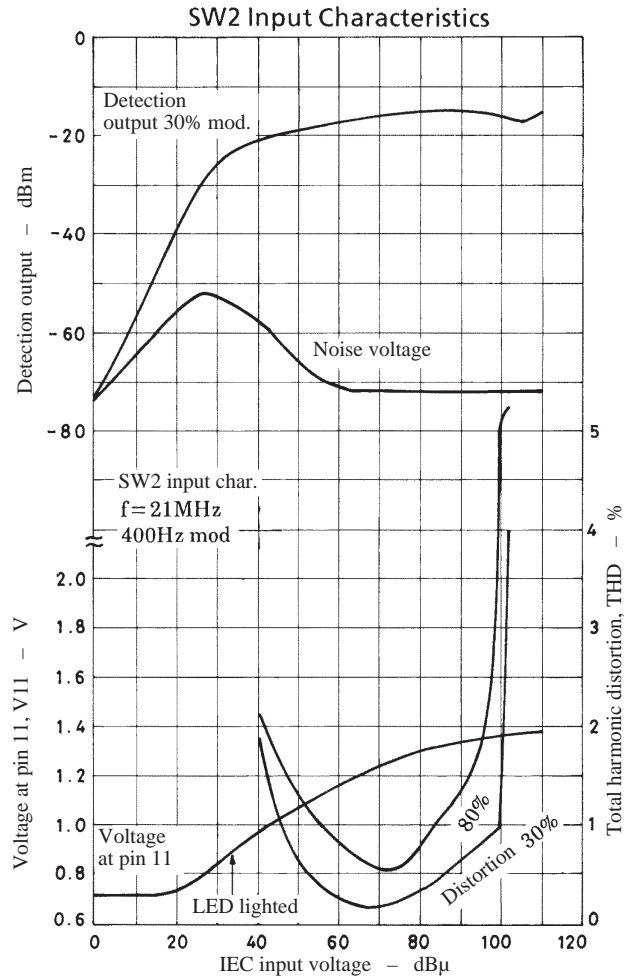
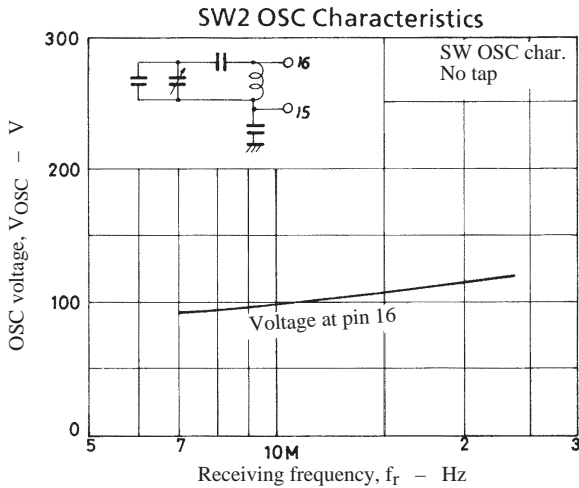
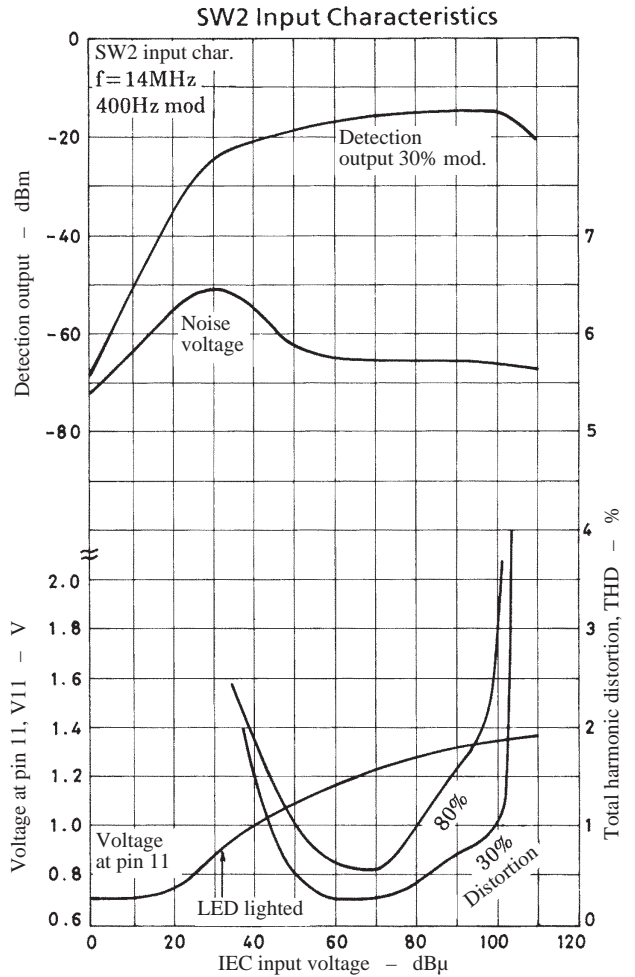
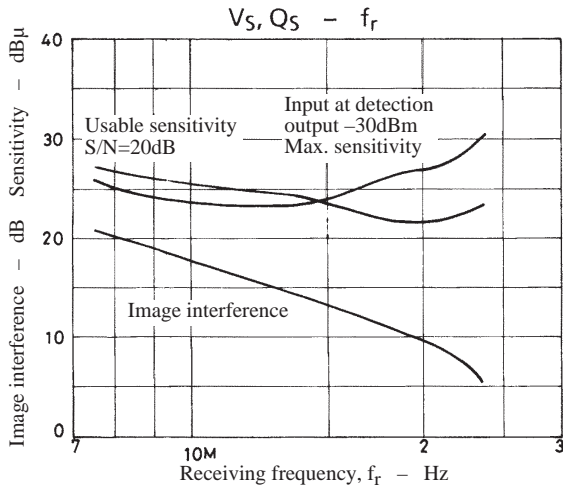

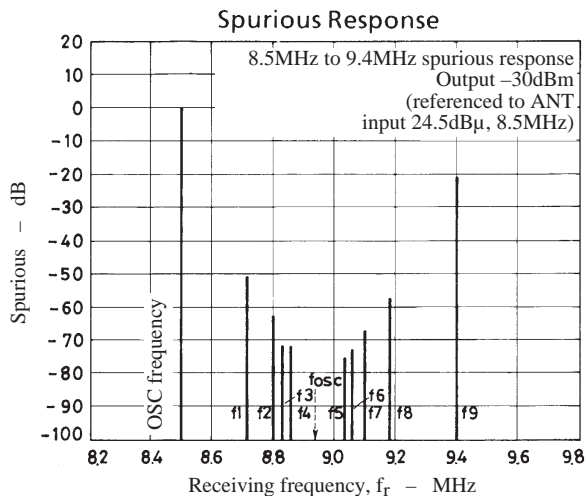
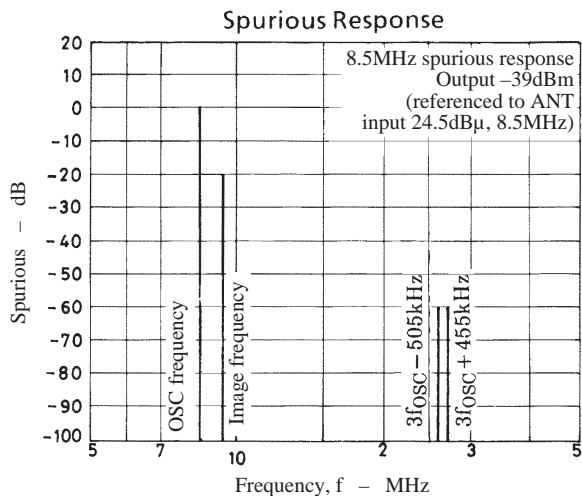

- $f_1 : 8.729\text{MHz} \rightarrow 2f_{OSC} - 2f_1 = 455\text{kHz}$
- $f_2 : 8.803\text{MHz} \rightarrow 3f_{OSC} - 3f_2 = 455\text{kHz}$
- $f_3 : 8.840\text{MHz} \rightarrow 4f_{OSC} - 4f_3 = 455\text{kHz}$
- $f_4 : 8.864\text{MHz} \rightarrow 5f_{OSC} - 5f_4 = 455\text{kHz}$
- $f_5 : 9.047\text{MHz} \rightarrow 5f_5 - 5f_{OSC} = 455\text{kHz}$
- $f_6 : 9.069\text{MHz} \rightarrow 4f_6 - 4f_{OSC} = 455\text{kHz}$
- $f_7 : 9.107\text{MHz} \rightarrow 3f_7 - 3f_{OSC} = 455\text{kHz}$
- $f_8 : 9.183\text{MHz} \rightarrow 2f_8 - 2f_{OSC} = 455\text{kHz}$

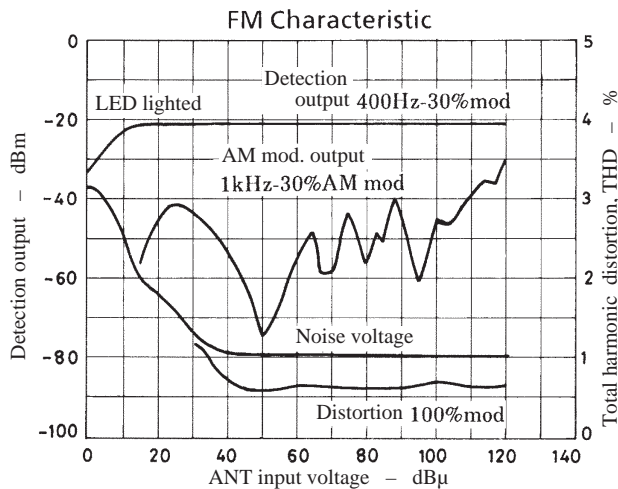
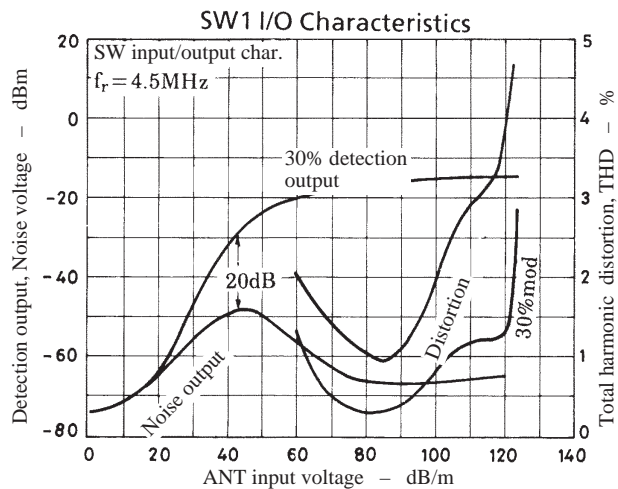

LA1260

Sample Application Circuit 2 : FM (band in US) /MW/SW1 (2.2 to 7.5MHz) /SW2 (7.2 to 24.0MHz)

Application where the LA1185 and LA1260 are used

[Circuit Diagram] (The sample printed circuit pattern is shown on page 13.)

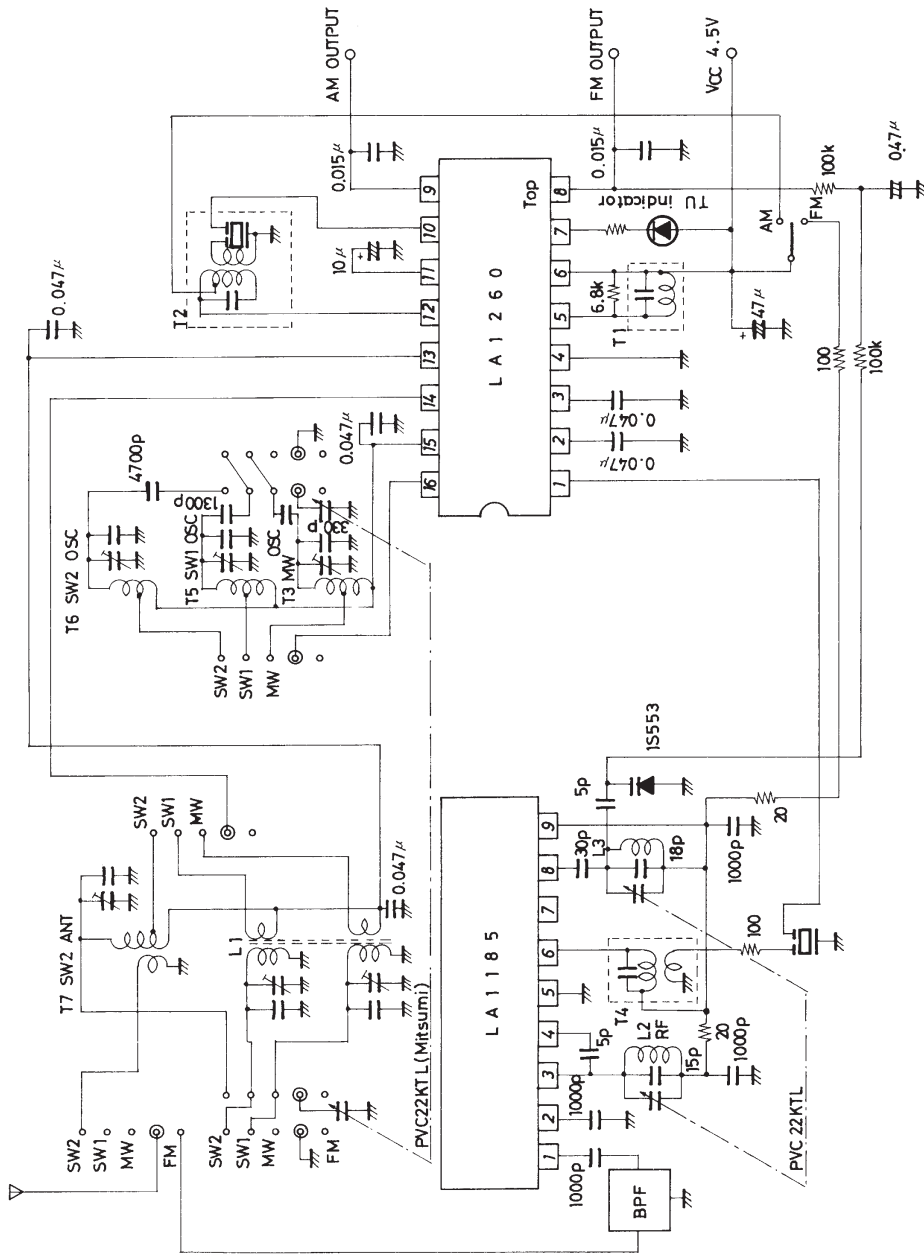

- L1 TN10896 bar antenna (Mitsumi)
- T2 5.5mmφ air core 0.88mm wire 4T RF
- L3 5.5mmφ air core 0.88mm wire 3T OSC
- T1 YT-30194 (Mitsumi),
2153-4095-339 (Sumida)
- T2 KW-30011 (AM Mix)
- T3 YT-30105 (Mitsumi)
- T4 YT-30224 (Mitsumi)
- T5 YT-30134 (Mitsumi)
- T6 YT-30112 (Mitsumi)
- T7 YT-30117 (Mitsumi)
2158-4140-044 (Sumida)

T4 : YT-30224 (Mitsumi)
FM IF

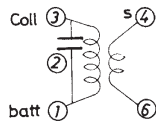

①-③ 8T, ④-⑥ 2T
0.12mm 2UEW
Internal 100pF, external 5pF
 $f_0 = 10.7\text{MHz}$, $Q_0 = 80$

Unit (resistance : Ω , capacitance : F)

Sample Printed Circuit Pattern : Cu-foiled area (The circuit diagram is shown on page 12.)

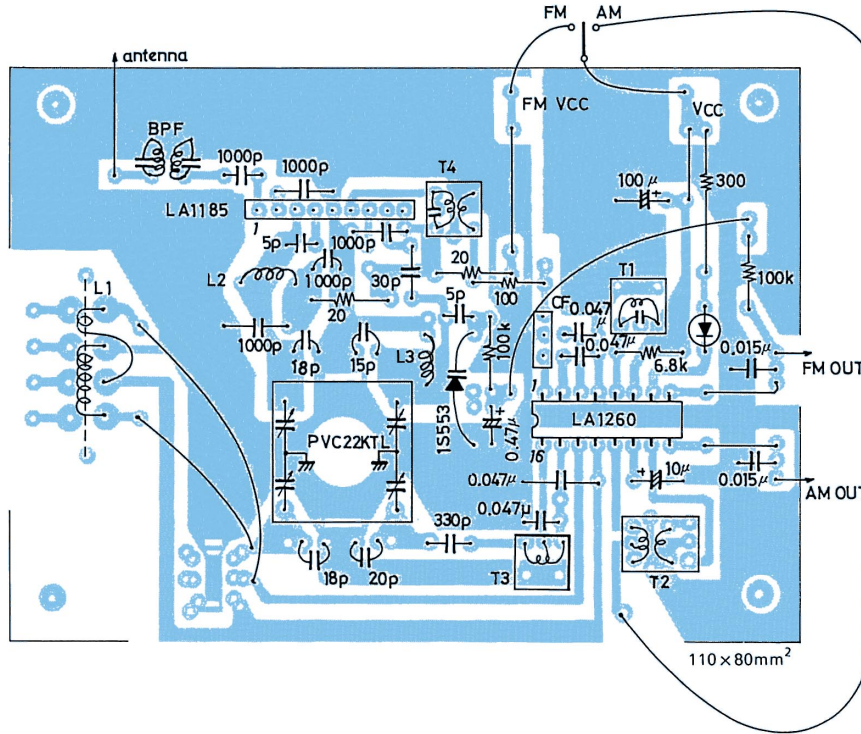

Unit (resistance : Ω, capacitance : F)

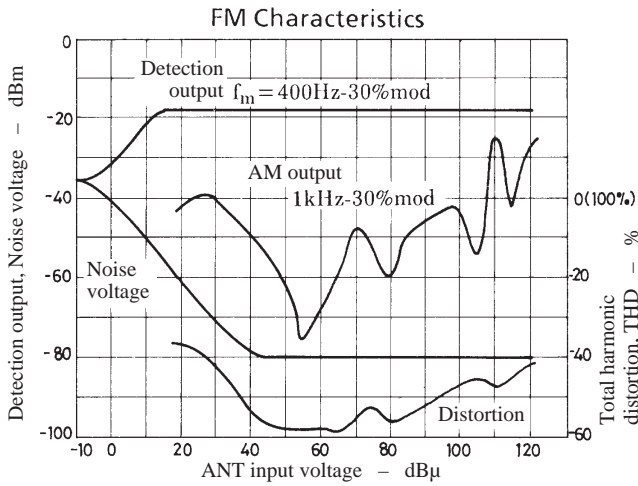

$f_r = 108\text{MHz}$
 $V_{CC} = 4.5\text{V}$
 $Q.S. = 9.5\text{dB}\mu$
 $-3\text{dB L.S.} = 9\text{dB}\mu$
 LED lighting sensitivity $11.5\text{dB}\mu$

- Applications where a double tuning coil is used (See page 3.)

The use of the following coil improves the distortion approximately 0.1% at 100% modulation.

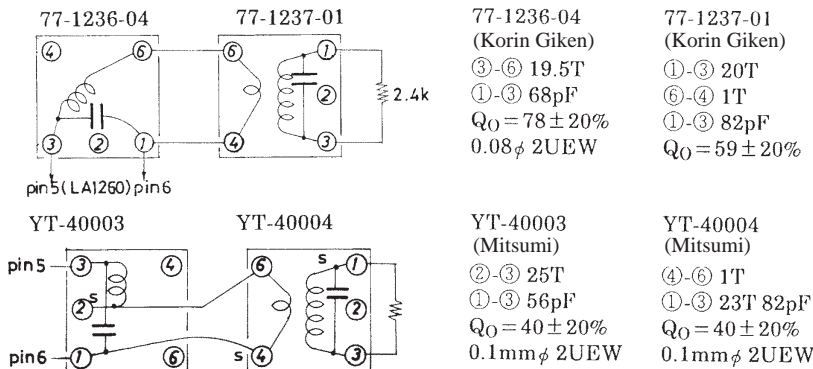

- No products described or contained herein are intended for use in surgical implants, life-support systems, aerospace equipment, nuclear power control systems, vehicles, disaster/crime-prevention equipment and the like, the failure of which may directly or indirectly cause injury, death or property loss.
- Anyone purchasing any products described or contained herein for an above-mentioned use shall:
 - ① Accept full responsibility and indemnify and defend SANYO ELECTRIC CO., LTD., its affiliates, subsidiaries and distributors and all their officers and employees, jointly and severally, against any and all claims and litigation and all damages, cost and expenses associated with such use:
 - ② Not impose any responsibility for any fault or negligence which may be cited in any such claim or litigation on SANYO ELECTRIC CO., LTD., its affiliates, subsidiaries and distributors or any of their officers and employees jointly or severally.
- Information (including circuit diagrams and circuit parameters) herein is for example only; it is not guaranteed for volume production. SANYO believes information herein is accurate and reliable, but no guarantees are made or implied regarding its use or any infringements of intellectual property rights or other rights of third parties.

This catalog provides information as of November, 1997. Specifications and information herein are subject to change without notice.